



**BULGARIA | CHINA | INDIA | MEXICO | THAILAND**

# MOLD SOLUTIONS

**All in one:  
We are a one-stop contract manufacturer.**



# BENEFITS OF WORKING WITH VEM



## **HIGH TECH TOOL & INJECTION SHOPS**

German owned with western management on site, high-quality equipment

## **TECHNICAL SUPPORT IN NORTH AMERICA AND EUROPE**

for mold design in special projects

## **COMPLETE PROJECT MANAGEMENT**

with English speaking engineers and management

## **USMCA & EUROPE BASE**

contract-tool-shops for warranty and modifications



# HISTORY - VEM GROUP

1998

## Start

Company registered in Hong-Kong as VEM - Virtual Electronics Manufacturing Ltd

01

2008

## VEM Thailand

Set up 100% owned factory in Rayong, Thailand, 3000sqm

03

2019

## VEM Europe

Set up 100% owned factory in Plovdiv, Bulgaria, 2000sqm

05

2022

## VEM Thailand

Added another 5000sqm factory in Rayong, Thailand.

07

2003

## VEM China

Set up 100% owned factory in Shenzhen, China, 5000sqm

02

2016

## VEM India

Set up 100% owned factory in Pune, India, 1500sqm

04

2020

## VEM Mexico

Set up 100% owned factory in Queretaro, Mexico, 2 facilities with total of 3000sqm

06

2024

## VEM China

Added a clean room and ISO 13485 certification

08



## QUALITY CERTIFICATIONS

### China

- ISO 9001
- ISO 13485

### Thailand

- ISO 9001
- ISO 13485
- IATF 16949
- AS9100
- ISO class 7 clean room
- ISO class 8 clean room

### India

- ISO 9001
- IATF 16949

### Mexico

- ISO 9001
- IATF 16949

### Bulgaria

- ISO 9001



## REFERENCE CUSTOMER



**ISUZU**



**zollner**

**AUTOMOTIVE**

**AEROSPACE**



# AUTOMOTIVE

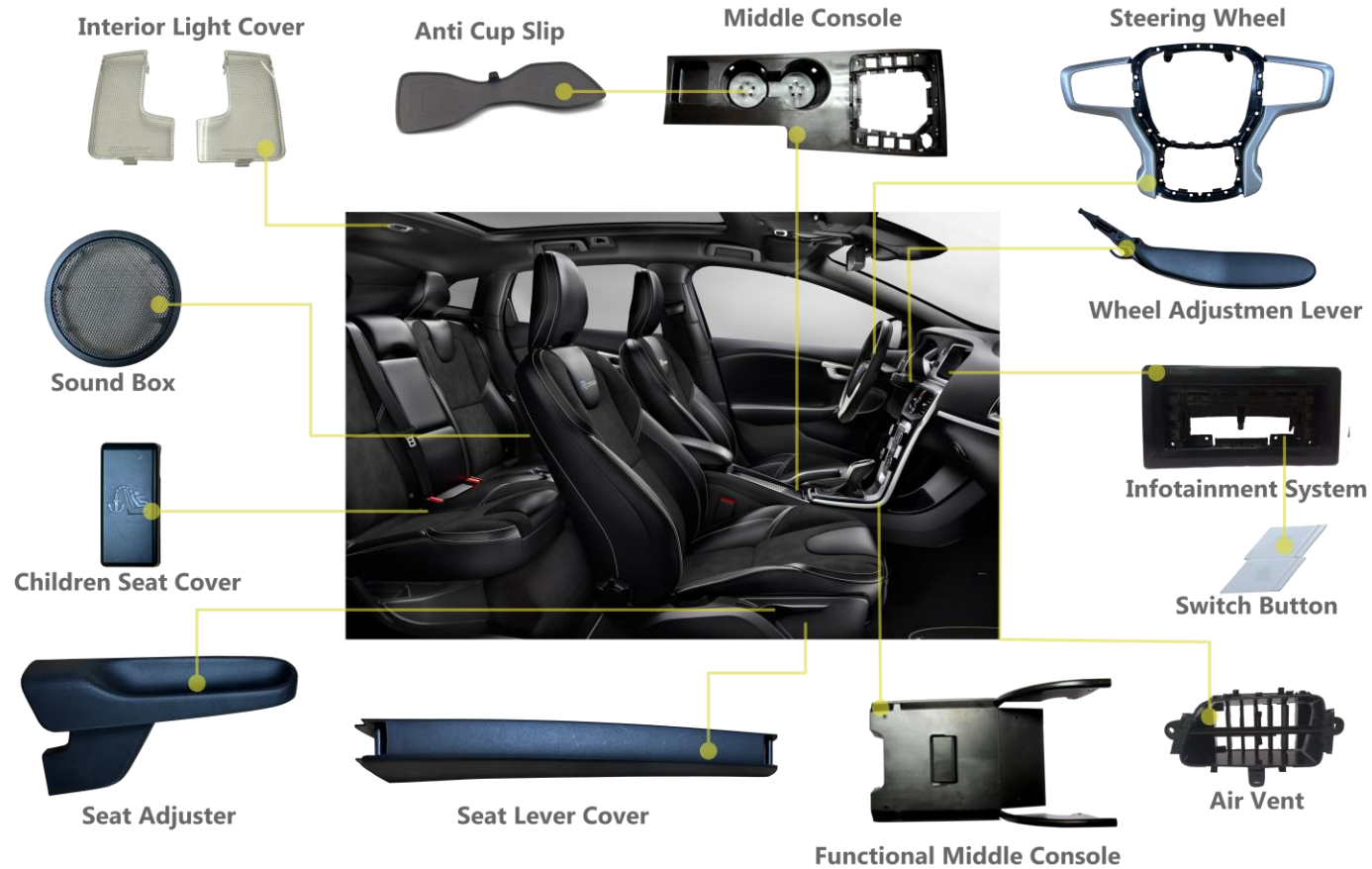



# REFERENCE PARTS

# AUTOMOTIVE

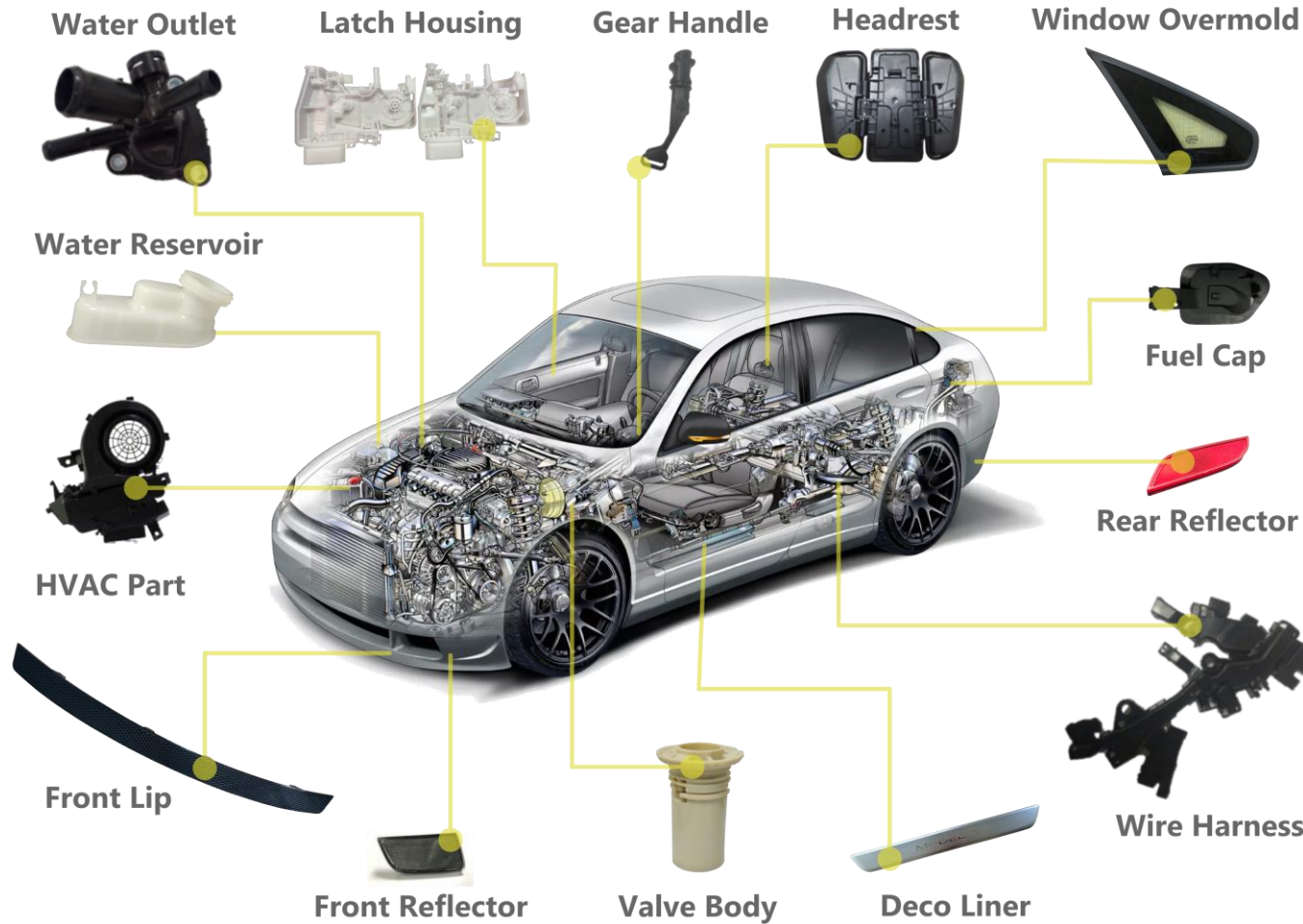





# REFERENCE PARTS

# AEROSPACE





# AEROSPACE

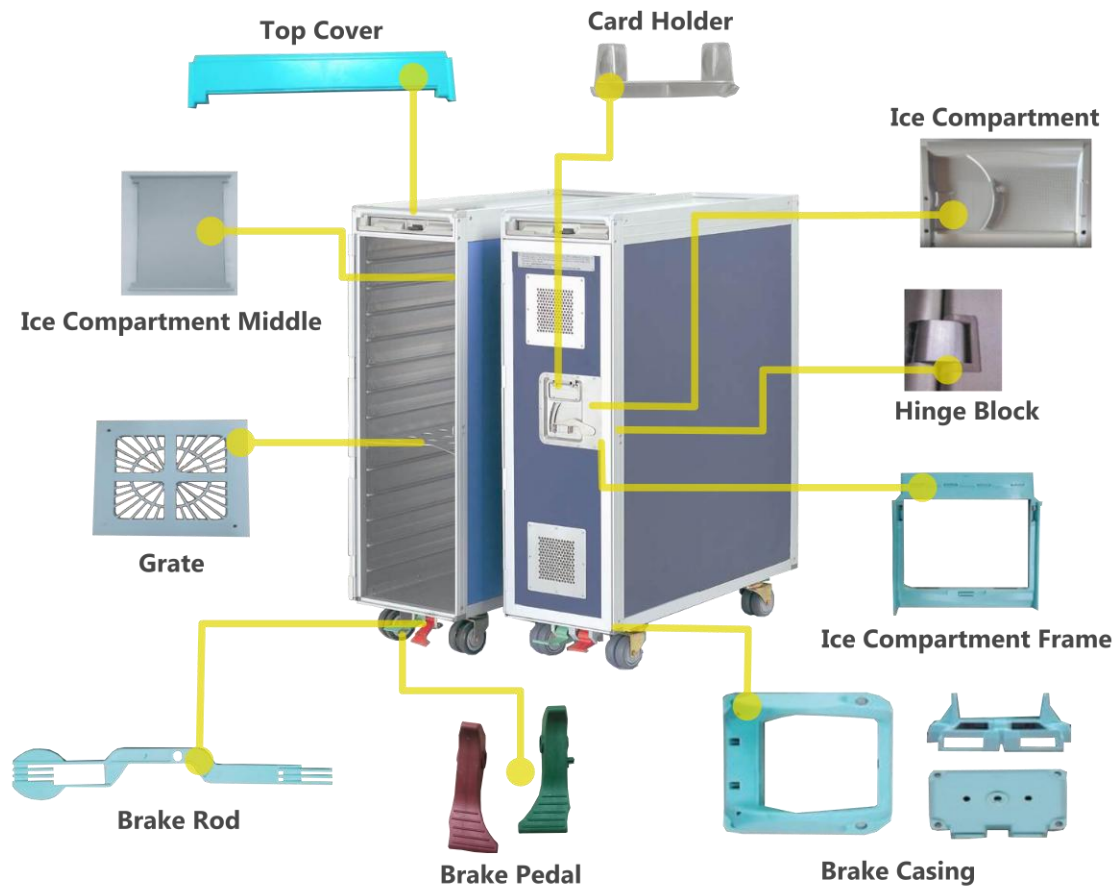



## REFERENCE CUSTOMER



Edwards



MASTERFLEX®



**Baxter**



# MEDICAL



REFERENCE PARTS

## VENTILATION SYSTEM FOR HOME CARE

# MEDICAL

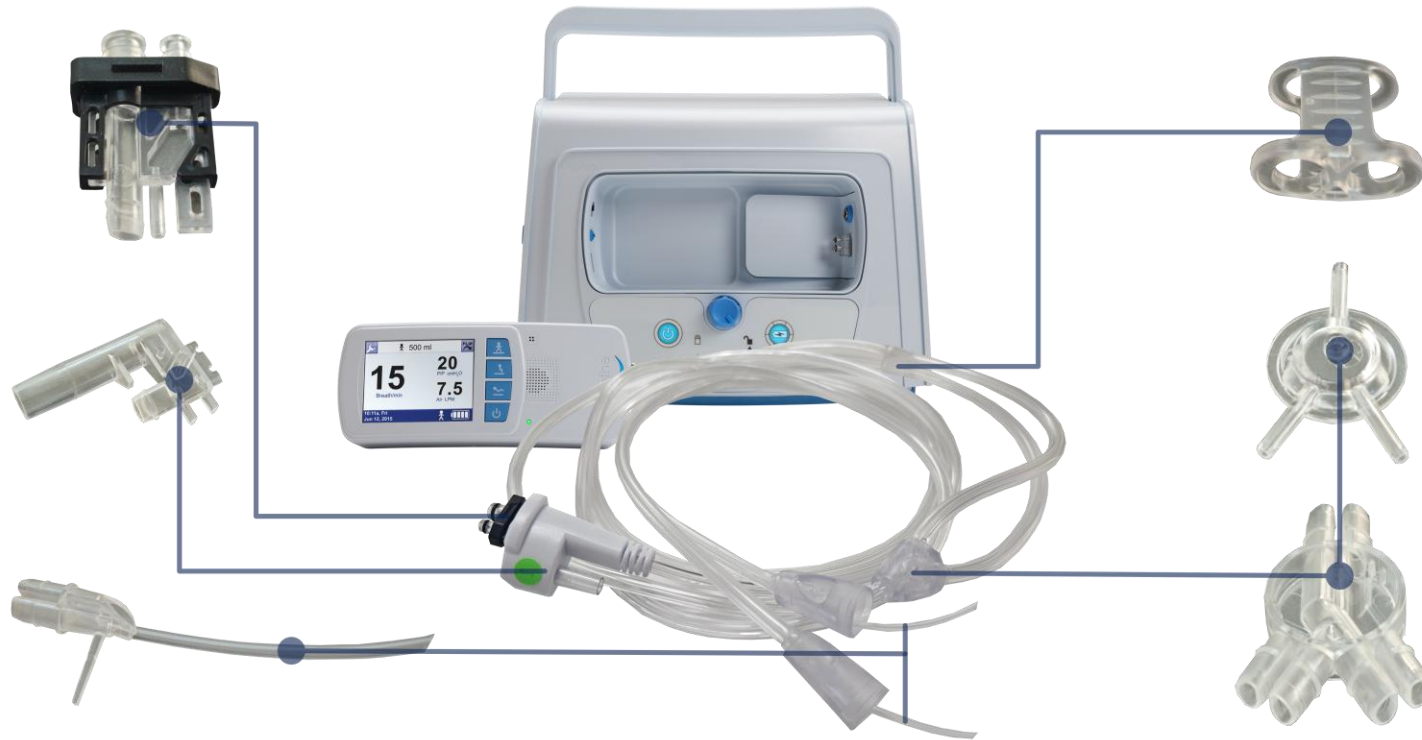



REFERENCE PARTS

## PCR TESTING PLATFORM

# MEDICAL





REFERENCE CUSTOMER



*Zuhause im Freien*

SIEMENS



CONSUMER



mecalitgroup



Be Right™



connectwell  
THE RIGHT CONNECTION



## REFERENCE PARTS

# CONSUMER





## REFERENCE CUSTOMERS



**BOSCH**

**SIEMENS**



**YAZAKI**

**bankz  
POWER**

A logo icon for Sensata Technologies consisting of a grid of colored dots in blue, green, and red.  
**Sensata**  
Technologies

**Leuze**

**ELECTRONIC**





## REFERENCE PARTS

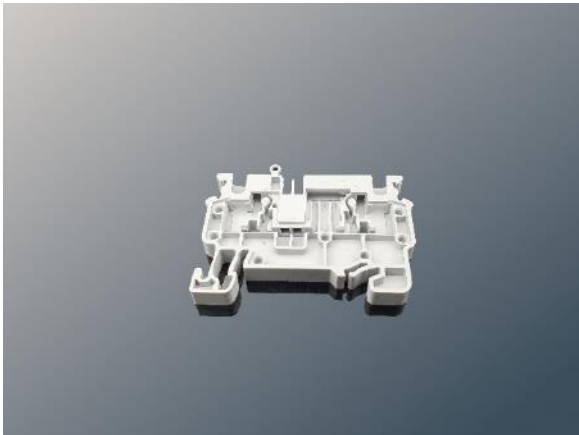
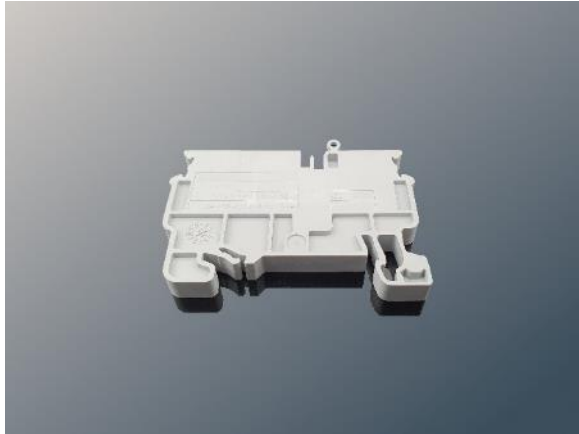

## ELECTRONIC





# GLOBAL COMPANY WITH A LOCAL FOOTPRINT

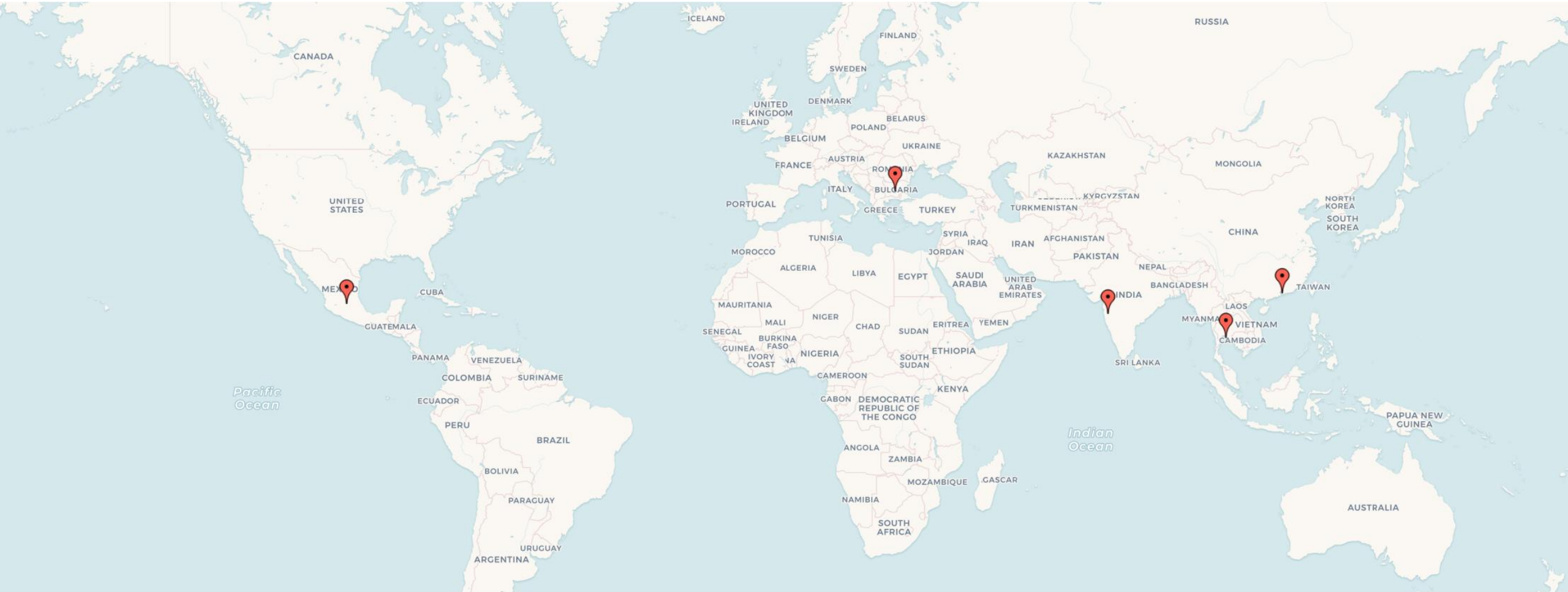



VEM CHINA



VEM CHINA  
SHENZHEN



**VEM CHINA**

- **High-precision tool shop, machinery from Switzerland, Japan and Germany**



- **Steel 3D printing & strict QC documentation after every process**



- Injection shop with Arburg machines





**VEM THAILAND**



**VEM THAILAND  
RAYONG**



30+ Injection molding machines

Machine range 5 TON to 850 TON

Fully equipped with desiccant dryers, HR controllers, MTC,  
Bimetallic barrel







## ISO 7 CLEANROOM

Clean Room ISO 7 / Class 10,000 (Video tour: <https://youtu.be/-jyKbd6Vmsg>)





High Level of Production Automation on our product lines.





Clean Room ISO 8 / Class 100,000 Molding (Video tour: <https://youtu.be/-jyKbd6Vmsg>)





**VEM EUROPE**



# VEM EUROPE PLOVDIV



**VEM EUROPE**

- **High-precision tool shop, machinery from Switzerland and Germany**



- Injection shop with Arburg machines







## FACTORY 1 (EL MARQUES)

**Size:**  
1000 sqm

**Machines:**  
4 Injection machines  
(50t – 470t)

**Specialties:**  
Vertical Injection, 2K Molding  
Assembly line

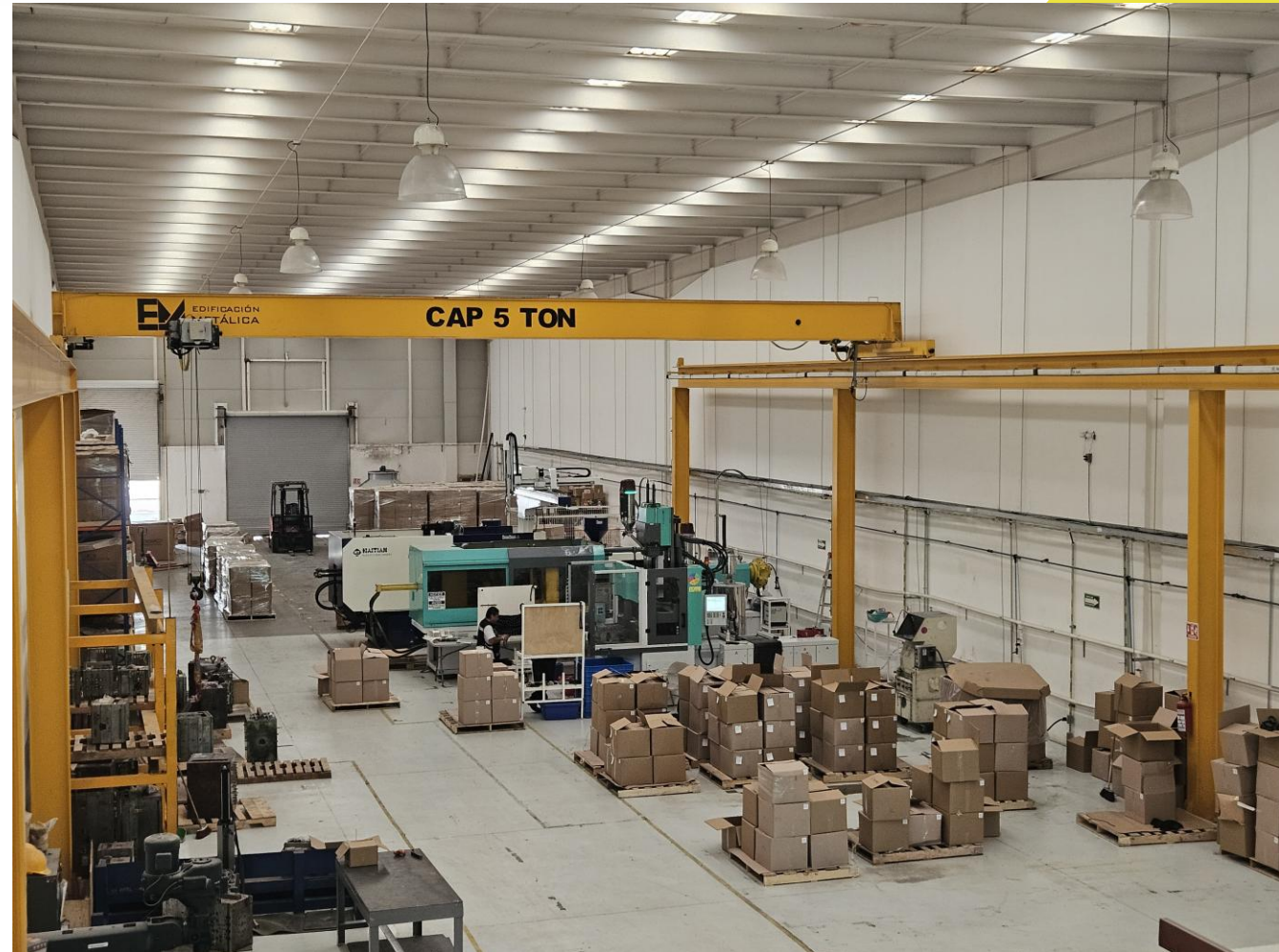





## FACTORY 1 (EL MARQUES)

### Vertical injection molding: Including assembly line





## **2K Injection Molding: Including assembly line**





## FACTORY 1 (EL MARQUES)

**Assembly:**  
Several assembly lines





## FACTORY 2 (LA BOMBA)

### Size:

2000 sqm

### Machines:

14 Injection machines (50t – 730t)

### Specialties:

Larger machines (up to 730t)  
Assembly line





## FACTORY 2 (LA BOMBA)

Various assembly lines, high-tech quality control





**VEM INDIA  
PUNE**



VEM INDIA

## Injection molds, Prototype molds in 3-4 weeks





VEM INDIA

## High-tech quality control, 3D steel printing

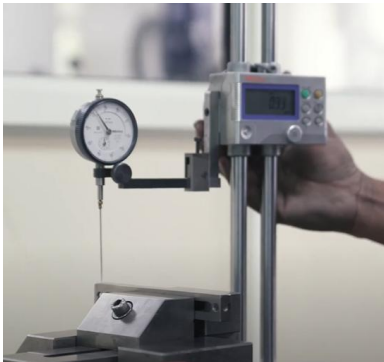
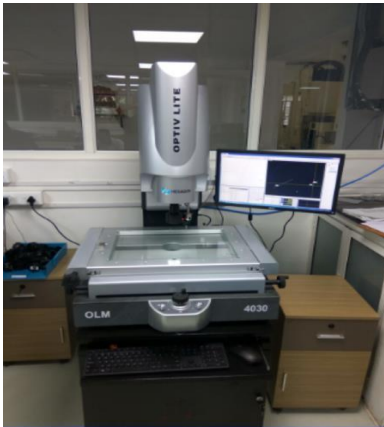





VEM INDIA

## Tool shop and injection molding (max. 850t)





**GET IN TOUCH**



**Billy Xia**

Plant Manager, BOD Member



**Milind Patil**

Plant Manager



**Silvio Pereira**

Plant Manager



**Ricardo Silva**

Plant Manager



**Gopal Kabra**

Plant Manager



# INTERNATIONAL SALES TEAM



**Toben King**  
Sales North/East USA



**Marilyn Kahler**  
Sales Arizona USA

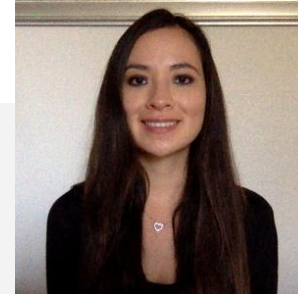

**Paulina Lagunas**  
Sales New England USA



**Pablo Loza**  
Sales East USA



**Andrea Abella**  
Sales West USA



**Paula Larson**  
Sales South USA

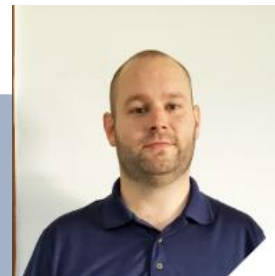

**Bryan Carroll**  
USA Tooling Expert



## INTERNATIONAL SALES TEAM



**Gopal Kabra**  
Sales India



**Nina Koleva**  
Sales East Europe

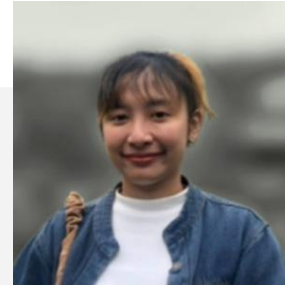

**Rujeerat Chaisiri**  
Sales Thailand

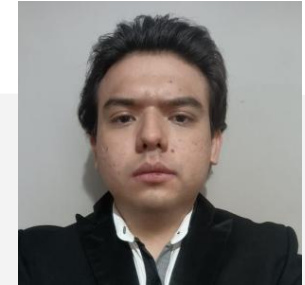

**Alejandro Padilla**  
Sales Mexico



**Lily Zou**  
Sales Asia



**Joachim Eitel**  
Sales Germany/DACH



**Mike Cunningham**  
Sales NLD & BEL



## SALES OFFICES

### VEM USA

#### North/East USA

toben.king@vem-ltd.com

#### Southwest USA

marilyn.kahler@vem-ltd.com

#### South USA

paula.larson@vem-ltd.com

#### New England USA

paulina.lagunas@vem-ltd.com

### VEM USA

#### East USA

pablo.loza@vem-ltd.com

#### West USA

andrea.abella@vem-ltd.com

#### Technical Sales

bryan.carroll@vem-ltd.com

### VEM Mexico

#### Mexico

andrea.abella@vem-ltd.com

#### Mexico

sales02.mexico@vem-ltd.com

### VEM Europe

#### Germany, Frankfurt

joachim.eitel@vem-ltd.com

#### East Europe, Plovdiv

nina.koleva@vem-ltd.com

#### Netherlands, Rotterdam

mike.cunningham@vem-ltd.com

### VEM India

#### Pune

g.kabra@vem-ltd.com

### VEM China

#### Shenzhen

lily.zou@vem-ltd.com

### VEM Thailand

#### Rayong

rujeerac@vem-ltd.com  
max.zm@vem-ltd.com



**German Precision,  
American Service,  
Asian Prices.....  
that's VEM**



# MACHINE LIST CHINA



VEM Tooling(Shenzhen)Co.,Ltd.  
维克多精密工业(深圳)有限公司





## MACHINE LIST CHINA

Type	Type2	Manufacturer	Model	Description		Year	Quantity
CNC Milling		MIKRON	HSM300	+/- 0.003	mm	2008	1
CNC Milling		MIKRON	HSM400	+/- 0.003	mm	2006	1
CNC Milling		MIKRON	HSM500	+/- 0.003	mm	2008	1
CNC Milling		MIKRON	VCP600	+/- 0.003	mm	2005	1
CNC Milling		MIKRON	VCP1000	+/- 0.003	mm	2006	1
CNC Milling		MORI SEIKI	NV4000 DCG	+/- 0.003	mm	2004	1
CNC Milling		JOINT	VMC1060	+/- 0.01	mm	2016	1
CNC Milling		JOINT	VMC1270	+/- 0.01	mm	2016	1
CNC Milling		YCM	TV158B	+/- 0.01	mm	2016	2
CNC Milling		MAKINO	V33i	+/- 0.003	mm	2020	1
CNC Milling		SMD	SMD-HG600	+/- 0.01	mm	2020	1
CNC Milling		SMD	SMD-H600	+/- 0.01	mm	2017	1
CNC Milling		MORI SEIKI	NL1500MC/500	+/- 0.005	mm	2008	1



# MACHINE LIST CHINA

Type	Type2	Manufacturer	Model	Description		Year	Quantity
Die sinking EDM		FT	CNC850	+/- 0.02	mm	2011	1
Die sinking EDM		CHMER	CM655+70N	+/- 0.01	mm	2007	1
Die sinking EDM		CHMER	CM434C+50N+D434	+/- 0.01	mm	2004	1
Die sinking EDM		CHMER	CM-434C	+/- 0.01	mm	2007	1
Die sinking EDM		CHMER	323C+50N	+/- 0.01	mm	2013	1
Die sinking EDM		FT	CNC-450	+/- 0.02	mm	2019	1
Die sinking EDM		Agie Charmilles	FORM200BP	+/- 0.005	mm	2015	1
Die sinking EDM		Agie Charmilles	FORM200BP	+/- 0.005	mm	2016	1
Die sinking EDM		Agie Charmilles	FORM350BP	+/- 0.005	mm	2017	1
Die sinking EDM		Agie Charmilles	FORM350BP	+/- 0.005	mm	2020	1
Die sinking EDM		Agie Charmilles	FORM350BP	+/- 0.005	mm	2020	1
Die sinking EDM		Agie Charmilles	FORM350BP	+/- 0.005	mm	2021	1
Die sinking EDM		BEST	ZNC-435	+/- 0.04	mm	2020	1
Die sinking EDM		BEST	BEST-430	+/- 0.04	mm	2020	1
Die sinking EDM		BEST	BEST-348	+/- 0.04	mm	2020	1
3D steel printer		BLT3D	BLT-A320	+/- 0.2	mm	2021	1
Wire EDM		Agie Charmilles	DRILL20	+/- 0.04	mm	2007	1
Wire EDM		Agie Charmilles	PROGRESS V2	+/- 0.002	mm	2005	1
Wire EDM		Agie Charmilles	PROGRESS	+/- 0.002	mm	2007	2
Wire EDM		BAOMA	DK7763D	+/- 0.02	mm	2008	3
Wire EDM		Agie Charmilles	CUTP350	+/- 0.005	mm	2017	1
Wire EDM		Agie Charmilles	CUTP350	+/- 0.005	mm	2018	1
Wire EDM		Agie Charmilles	CUTP350	+/- 0.005	mm	2020	1



# MACHINE LIST CHINA

Type	Type2	Manufacturer	Model	Description		Year	Quantity
Grinder		YU QING	LSG-618S	+/- 0.005	mm	2010	1
Grinder		YU QING	LSG-618S	+/- 0.005	mm	2010	1
Grinder		YU QING	LSG-618S	+/- 0.005	mm	2012	1
Grinder		YU QING	YSG-618	+/- 0.005	mm	2008	1
Grinder		HYBEST	HB-618	+/- 0.005	mm	2010	1
Grinder		HYBEST	HB-618	+/- 0.005	mm	2005	1
Grinder		JIAN DE	KGS-84AHK	+/- 0.01	mm	2005	1
Grinder		JIAN DE	KGS-84AHK	+/- 0.01	mm	2021	1
Grinder		JIAN DE	KGS-250M	+/- 0.005	mm	2005	1
Grinder		Easson	EP-1	+/- 0.02	mm	2005	1
Milling		MODEL	UE-712A	+/- 1	mm	2013	1
Milling		HOLD	HDSKGSJM30-1500	+/- 0.1	mm	2019	1
Milling		HUEN CHEN	HC-900	+/- 0.05	mm	2004	1
Milling		JIAN DE	3K	+/- 0.02	mm	2004	7
Lathe		JIAN YI	C6140A	+/- 0.02	mm	2004	1
Lathe		SHENYANG	CW6180B	+/- 0.02	mm	2007	1
Radial drilling		精准 DH	DH 800DC	+/- 0.08	mm	2021	1
		众联激光	ZL-BX30F	+/- 0.1	mm	2017	1
		SYNCROWACE250DX	MF150362L	+/- 0.5	mm	2015	1
Laser welding		HAN,S LASER	HY1281508052	+/- 0.2	mm	2015	1
Fitting machine		NICE	NC120-1310	+/- 0.05	mm	2020	1



# MACHINE LIST CHINA

Type	Type2	Manufacturer	Model	Description		Year	Quantity
Injection	Electric	TOSHIBA	EC75ST	75	T	2016	1
Injection	Electric	TOSHIBA	EC100N II-2A 100T	100	T	2006	1
Injection	Hydraulic	NISSEI	FNX180 III T-25A	180	T	2016	1
Injection	Electric	TOSHIBA	EC220N II-6A 220T	220	T	2006	1
Injection	Electric	TOSHIBA	EC350N II-17A 350T	350	T	2026	1
Injection	Hydraulic	NISSEI	FNX180 III T-25A	180	T	2020	1
Injection	Electric	NISSEI	NEX110 IV-1E	110	T	2020	1
Injection	Hydraulic	ARBURG261579	570 E 2000-800	200	T	2022	1
Injection	Hydraulic	ARBURG262223	570 E 2000-800	200	T	2022	1
Injection	Hydraulic	ARBURG258508	570 E 2000-800	200	T	2022	1
Injection	Hydraulic	ARBURG263293	570 E 2000-800	200	T	2022	1
Injection	Hydraulic	ARBURG263163	570 E 2000-800	200	T	2022	1
Injection	Hydraulic	ARBURG261933	570 E 2000-800	200	T	2022	1
Injection	Hydraulic	BORCHE	BM320-080ML	320	T		1
	CMM	HEXAGON	7.10.7 Global class	+/- 0.001	mm	2015	1
	CMM	HEXAGON	Explorer Classic 06.08.06	+/- 0.001	mm	2020	1
	CMM	HEXAGON	Explorer05.07.05	+/- 0.001	mm	2017	1
	VMM	RATIONAL	VMS-4030F	+/- 0.001	mm	2007	1
	VMM	ACCURAL	4030	+/- 0.001	mm	2016	1
	Height gage	MITUTOYO	QM-height 600	+/- 0.001	mm	2005	1
	Hardness	DECHUAN	HR150A	+/- 0.5	mm	2004	1
	Hardness	TIME	5301	+/- 0.1	mm	2016	1



**VEM THAILAND**



# MACHINE LIST THAILAND



# MACHINE LIST THAILAND

Type	Type2	Manufacturer	Model	Description		Year	Quantity
Injection	Electric	CHRISTMANN	BABYPLAST 6/10P	0.5	T	2018	1
Injection	Vertical	JIN TONG	JT-250	30	T	2018	1
Injection	Vertical	JIN TONG	JT-250	30	T	2018	1
Injection	Vertical	JIN TONG	JT-250	30	T	2018	1
Injection	Electric	SHIBAURA	EC50SXII-1A	50	T	2020	1
Injection	Electric	TOSHIBA	EC50SXII-1A	50	T	2018	1
Injection	Hydraulic	KRAUS MAFFEI	50-180-CX	50	T	2018	1
Injection	Hydraulic	CHEN HSONG	MJ55	55	T	2010	1
Injection	Hydraulic	CHEN HSONG	MJ55	55	T	2017	1
Injection	Hydraulic	KRAUS MAFFEI	80-180-CX	80	T	2018	1
Injection	Hydraulic	VAN DORN	VAN DORN EXTRA 90-43	90	T	2004	1
Injection	Hydraulic	CHEN HSONG	JM98Ai	98	T	2017	1
Injection	Electric	ARBURG	AIIROUNDER 470E 1000-290	110	T	2015	1
Injection	Electric	ARBURG	AIIROUNDER 470E 1000-290	110	T	2015	1
Injection	Electric	NISSEI	NEX-110-IV-1E	110	T	2021	1
Injection	Electric	SHIBAURA	EC130SXII-4A	130	T	2021	1
Injection	Electric	TOSHIBA	EC130ST-3A	130	T	2015	1
Injection	Electric	TOSHIBA	EC130ST-3A	130	T	2015	1
Injection	Electric	TOSHIBA	EC130ST-3A	130	T	2016	1
Injection	Hydraulic	CHEN HSONG	JM138-Ai	138	T	2010	1
Injection	Hydraulic	CHEN HSONG	JM178Ai	178	T	2017	1
Injection	Electric	TOSHIBA	EC180SX-6A	180	T	2018	1
Injection	Hydraulic	NISSEI	FNX-180-III-25A	180	T	2021	1
Injection	Hydraulic	NISSEI	FNX-180-III-25A	180	T	2021	1
Injection	Electric	ARBURG	AAROUNDER 570 E 2000-800	220	T	2015	1
Injection	Electric	TOSHIBA	EC 220 C-6 A	220	T	2008	1
Injection	Electric	SHIBAURA	EC280SX-10A	280	T	2022	1
Injection	Electric	TOSHIBA	EC280SX-10A	280	T	2019	1
Injection	Electric	SHIBAURA	EC350SXIII-17A	350	T	2021	1
Injection	Hydraulic	CHEN HSONG	EM400-SVP/2	400	T	2014	1
Injection	Hydraulic	VAN DORN	VAN DORN 400	400	T	1998	1
Injection	Hydraulic	TOSHIBA	IS 550 GSW-59 A	550	T	2008	1
Injection	Hydraulic	TOSHIBA	IS 850 GTW-i81 A	850	T	2006	1



## MACHINE LIST THAILAND

Type	Type2	Manufacturer	Model	Description		Year	Quantity
CNC		YCM	NXV 1020A	+/- 0.01	mm	2016	1
Smart scope		3D FAMILY	VMS 400	+/- 0.01	mm	2008	1
EDM		FT	EM CNC 450	+/- 0.02	mm	2017	1
Grinder		COMBITECH	Surface Grinder YSG-618	+/- 0.02	mm	2010	1
Wire EDM		BAOMA	DK7780D	+/- 0.02	mm	2013	1
EDM		AGIE CHARMILLES	ROBOFORM 35p	+/- 0.05	mm		1
EDM		CHMER	CM 434Z	+/- 0.05	mm	2009	1
Milling		FIRST	LC-185 B-VS	+/- 0.2	mm	2008	1
Turning		CHU SHING	ST-480x1000G	+/- 0.2	mm	2010	1
Drilling		HANTE	Z3040*13	+/- 0.5	mm	2008	1
Grinder		VERTEX	HF-818	NA	mm	2008	1
Laser welding		JANIN CHANGTAI	TPW-200W				1
Hardness tester		BOSCH					1
Band saw			HR-250A				1
TIG welding		V-ONE	WSE-315C				1
Ultrasonic cleaning		SANGHAI TENSE	TS-4800B				1



# MACHINE LIST INDIA





## MACHINE LIST INDIA

Type	Type2	Manufacturer	Model	Description		Year	Quantity
CNC Milling		YCM	NXV-1020A	+/- 0.01	mm	2019	1
CNC Milling		YCM	NXV-1020A	+/- 0.01	mm	2019	1
CNC Milling		YCM	NXV-1020A	+/- 0.01	mm	2016	1
CNC Milling		MIKRON	VCP 1000 DURO	+/- 0.02	mm	2016	1
CNC Milling		MIKRON	VCE 1000 PRO	+/- 0.02	mm	2016	1
CNC Milling		FEELER	VB-715	+/- 0.2	mm	2016	1
CNC Milling		JOINT	VMC-1270	+/- 0.03	mm	2016	1
CNC Milling		JOINT	VMC-1060	+/- 0.5	mm	2016	1
CNC Milling		SEN MAKE CNC	SMD-H600	+/- 0.01	mm	2019	1
CNC Milling		SEN MAKE CNC	SMD-HG600	+/- 0.01	mm	2023	1
CNC Milling		GF Mikron	Mill P 900	+/- 0.005	mm	2024	1
Gun Drill		Accurate	DH-800DC	+/- 0.02	mm	2020	1
CNC Cylindrical Grinding		Jones & Shipman	1300	+/- 0.01	mm	2016	1



## MACHINE LIST INDIA

Type	Type2	Manufacturer	Model	Description		Year	Quantity
Die sinking EDM		FT	CNC-450	+/- 0.03	mm		1
Die sinking EDM		FT	CNC-450	+/- 0.03	mm		1
Die sinking EDM		FT	CNC-450	+/- 0.03	mm		1
Die sinking EDM		FT	CNC-450	+/- 0.03	mm		1
Die sinking EDM		Chmer	6040L	+/- 0.002	mm		1
Die sinking EDM		Chmer	CM 434C	+/- 0.03	mm		1
Die sinking EDM		Chmer	CM434C	+/- 0.03	mm		1
Wire EDM		BAOMA	BMW-2008	+/- 0.003	mm		1
Wire EDM		AGIE	AGIECUT PROGRESS-2005	+/- 0.003	mm		1
Wire EDM		AGIE	AGIECUT PROGRESS-2005	+/- 0.003	mm		1
Spark drill		BAOMA	BMD-703	+/- 0.1	mm		1
3D metal printer		Ace Micromatic	STLR 400	+/- 0.2	mm		1



## MACHINE LIST INDIA

Type	Type2	Manufacturer	Model	Description	Year	Quantity
Grinding		KENT	KGS-84AHK	+/- 0.01 mm		1
Grinding		KENT	KGS-84AHK	+/- 0.01 mm		1
Grinding		SEEDTEC	LSG-518S	+/- 0.01 mm		1
Grinding		SEEDTEC	LSG-518S	+/- 0.01 mm		1
Grinding		HYFAIR	HF-818	+/- 0.005 mm		1
Manual milling		3A-S	GB4240	+/- 0.05 mm		1
Manual milling		3A-S	GB4240	+/- 0.05 mm		1
Bandsaw		TF	TFL-200E-D	+/- 0.02 mm		1
Bench grinder		GLORIOUS GEAR	BG-83			1
Laser welding		Tongfa	TFL - 200 E-D			1
Lathe		UNIVERSAL	C6140A1	+/- 0.1 mm		1



## MACHINE LIST INDIA

Type	Type2	Manufacturer	Model	Description	Year	Quantity
Injection	Hydraulic	Chen song	JM138-AI	138	T	1
Injection	Hydraulic	Toshiba	TS 100	100	T	1
Injection	Hydraulic	Toshiba	EC230SXII	230	T	1
Injection	Hydraulic	Toshiba	IS550GS-59A	550	T	1
Injection	Electric	Toshiba	EC50SXIII-1A	50	T	1
CMM		Mitutoyo	EURO-C-A544	+/- 0.002	mm	1
CMM		Hexagon	CROMA 8.10.6	+/- 0.002	mm	1
VMM		Hexagon	OPTIVLITE	+/- 0.005	mm	1
3D scanner		Okio	9M-HD	+/- 0.01	mm	1





# MACHINE LIST MEXICO

Type	Type2	Manufacturer	Model	Description	Year	Quantity
Injection	Electric	Toshiba	EC75SXII-2A	75	T	1
Injection	Electric	Haitian	MA 900M	90	T	1
Injection	Electric	Arburg	ALLROUNDER 470E	100	T	1
Injection	Electric	Arburg	ALLROUNDER 470E	100	T	1
Injection	Electric	Arburg	ALLROUNDER 470E	100	T	1
Injection	Electric	Arburg	ALLROUNDER 520 E	150	T	1
Injection	Electric	Arburg	ALLROUNDER 570E	200	T	1
Injection	Electric	Arburg	ALLROUNDER 570E	200	T	1
Injection	Hydraulic	Arburg	ALLROUNDER 720 S	300	T	1
Injection	Hydraulic	Arburg	ALLROUNDER 820S	400	T	1
Injection	Hydraulic	Van Dorn	85HT5-0966	85	T	1
Injection	Hydraulic	Van Dorn	170HT14-0981	170	T	1
Injection	Hydraulic	Van Dorn	230HT1220-1330	230	T	1
Injection	Hydraulic	Van Dorn	300HT20-3061	300	T	1
Injection	Hydraulic	Van Dorn	400-RS-48F-HT284	400	T	1
Injection	Hydraulic	Van Dorn	650HT2800-0299	650	T	1
Injection	Hydraulic	Van Dorn	730SP2800-0086	730	T	1
Injection	Hydraulic	Arburg Vertical	264187	160	T	1
Injection	Hydraulic	Haitian 2K	MA 4700M	470	T	1
SURFACE GRINDING		KENT	KGS-84		mm	1
SURFACE GRINDING		KENT	KGS-616 S		mm	1
EDM		CHMER	CM434C		mm	1
MILLING		VTC	MEA-25U-05-1227		mm	1
LATHE		GUANGZHOU	C6132Ai		mm	1
Projector		KEYENCE	IM-7030	+/- 0.008	mm	1
CMM		HEXAGON	Croma 8106	+/- 0.001	mm	1



# MACHINE LIST EUROPE



# MACHINE LIST EUROPE

Type	Type2	Manufacturer	Model	Description	Year	Quantity
CNC Milling		HERMLE	C400-3 axis	+/-0.008 mm	2019	1
CNC Milling		HERMLE	C32-5 axis	+/-0.008 mm	2019	1
CNC Milling		JOINT	VMC-1270	+/- 0.02 mm	2016	1
CNC Milling		JOINT	VMC-1060	+/- 0.02 mm	2016	1
CNC Milling		JOINT	VMC-1270L	+/- 0.02 mm	2023	1
CNC Milling		JOINT	VMC-V116P	+/- 0.02 mm	2023	1
CNC Milling		JOINT	VMC-V116P(15K)	+/- 0.02 mm	2023	1
Gun drill		Accurate	DH-800DC	+/- 0.02 mm	2020	1
Graphite CNC		SMD	SMD-HG600	+/- 0.005 mm	2019	1
Die sinking EDM		GF	Agie Charmilles FORM P350	+/- 0.008 mm	2019	1
Die sinking EDM		CHMER	CM-434C	+/- 0.01 mm	2016	1
Die sinking EDM		FT	CNC-450	+/- 0.01 mm	2016	1
Die sinking EDM		ONA	NX4F	+/- 0.005 mm	2022	1
Start hole EDM		Charmilles	Charmilles HD 30 CNC	mm	2005	1
Start hole EDM		Charmilles	Charmilles HD 30 CNC	mm	2023	1
Wire EDM		GF	AgieCharmilles CUT E 350	+/- 0.005 mm	2019	1





## MACHINE LIST EUROPE

Type	Type2	Manufacturer	Model	Description	Year	Quantity
Surface grinder		HF	HF-818	+/- 0.002 mm	2019	1
Surface grinder		SEE DTEC	LSG-618S	+/- 0.005 mm	2019	1
Surface grinder		KENT	KGS-615AHD	+/- 0.005 mm	2015	1
Lathe		Guangzhou	C6140A1/1000	+/- 0.05 mm	2020	1
Manual milling		Joint	Ratee 4E	+/- 0.02 mm	2020	1
Manual milling		FT	3K	+/- 0.02 mm	2010	1
Radial drill		HUEN Chen	HC1200	+/-0.05 mm	2019	1
Tool presetter		Haimer	Uno Premium	+/-0.002 mm	2019	1
Spotting press		AQUAmate Machinery Co	LS-120	+/- 0.1 mm	2016	1
Band saw		Weiren	GB4240	+/- 1 mm	2020	1
Laser engraving		ZL	ZL-BX30F	+/- 0.02 mm	2020	1
Laser welding		TF	TFL-200E-D	+/- 0.02 mm	2020	1
Sand blasting					2020	1



## MACHINE LIST EUROPE

Type	Type2	Manufacturer	Model	Description		Year	Quantity
Injection	Electric	Arburg	ALLROUNDER 570 E,GOLDEN	200	T	2020	1
Injection	Electric	Arburg	ALLROUNDER 520 E,GOLDEN	150	T	2020	1
Injection	Electric	Arburg	ALLROUNDER 370 E,GOLDEN	60	T	2021	1
Injection	Electric	Arburg	ALLROUNDER 820 S	400	T	2019	1
Injection	Electric	Arburg	ALLROUNDER 720 S	320	T	2020	1
CMM		Mitutoyo	CrystalPlusM574	+/- 0.002	mm	2021	1
3D scanner		Okio	9M-HD	+/- 0.01	mm	2022	1